

# KDI Marine Propulsion

40.8 - 50 HP

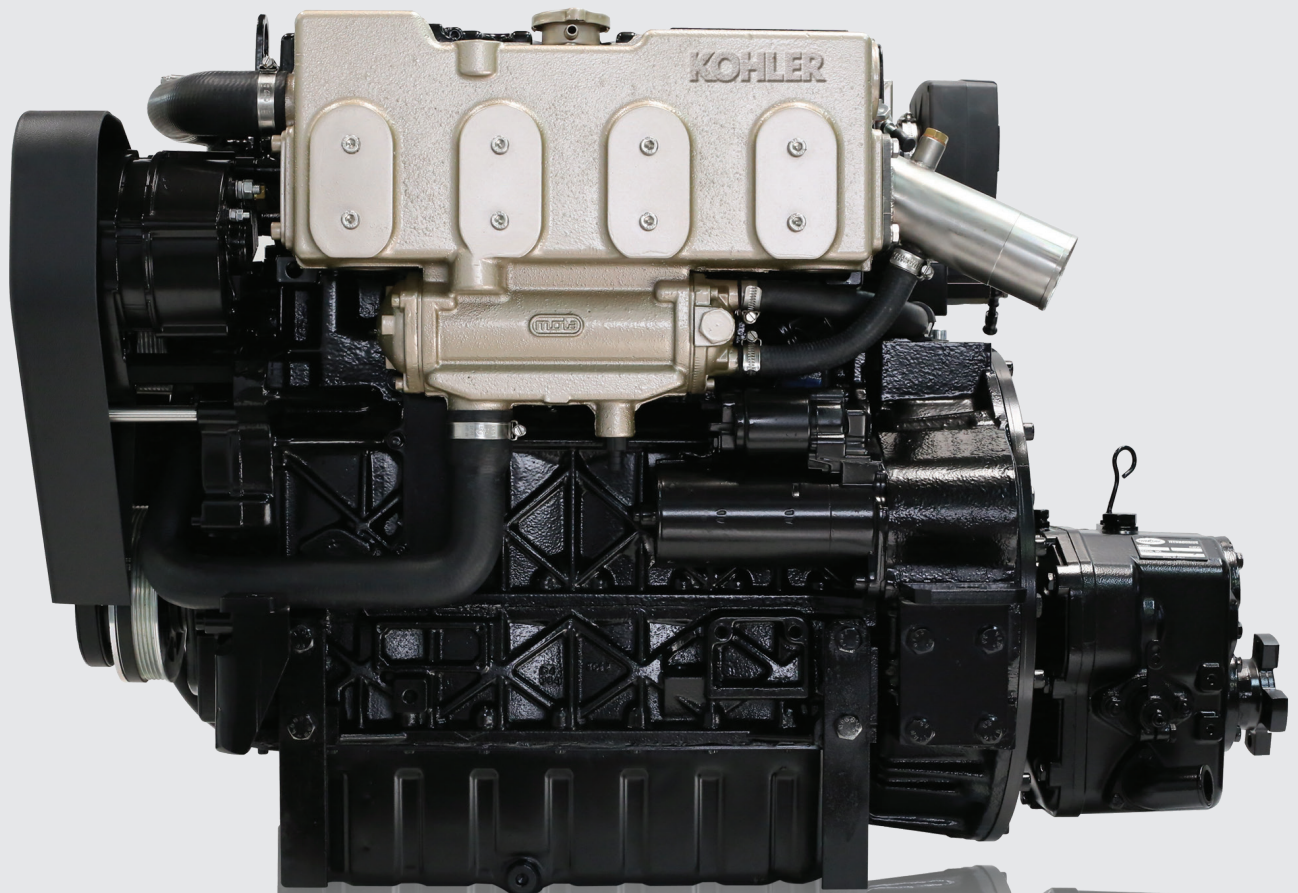

 **LOMBARDINI**  
**Marine**  
**KOHLER** Engines

# KDI 1903M-MP

## QUICK SPECIFICS

**3** Mechanical Engine  
CYLINDERS

**40.8** | **30.0** @ 2600 rpm  
HP kW STAGE III A

**133** @ 1500 rpm  
Nm



## DATA

### DIMENSIONS (mm)

KDI 1903M-MP with TMC60 marine gear

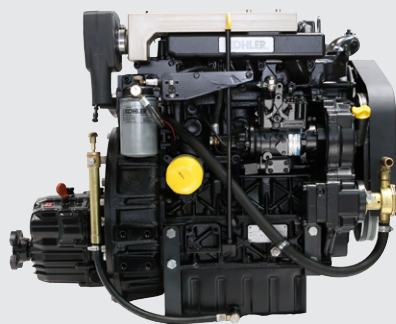
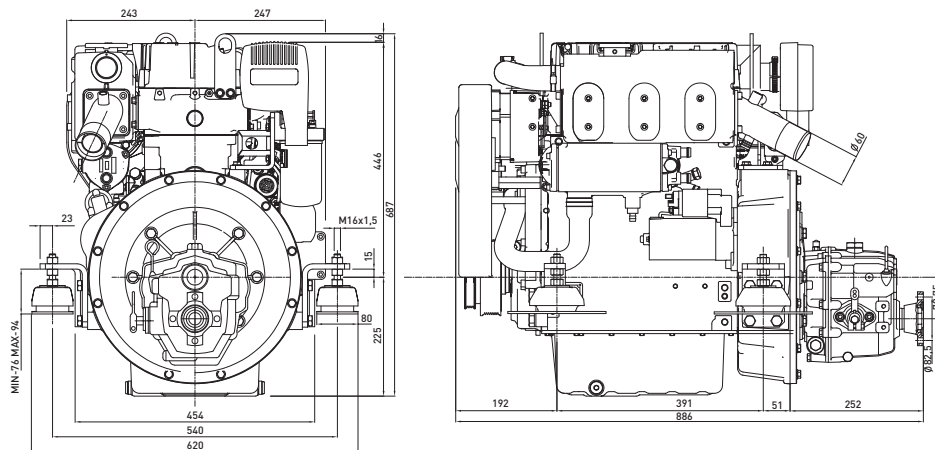

### STANDARD EQUIPMENT

- Digital De Luxe-panel
- Alternator 12V - 120A
- Electric starting
- Oil extraction pump
- 100Nm PTO facility
- V-belt safety cover
- Exhaust mixing elbow
- Fresh water expansion tank
- Sea water pump front mounted

### ACCESSORIES ON DEMAND

- Set of flexible engine mounts
- Hot water take-off kit
- Second station harness and panel
- Oil pressure sensor for Digital De Luxe-panel
- NMEA 2000 convertor for Engine monitory system

### PERFORMANCE CURVES (ACCORDING TO ISO 14396)

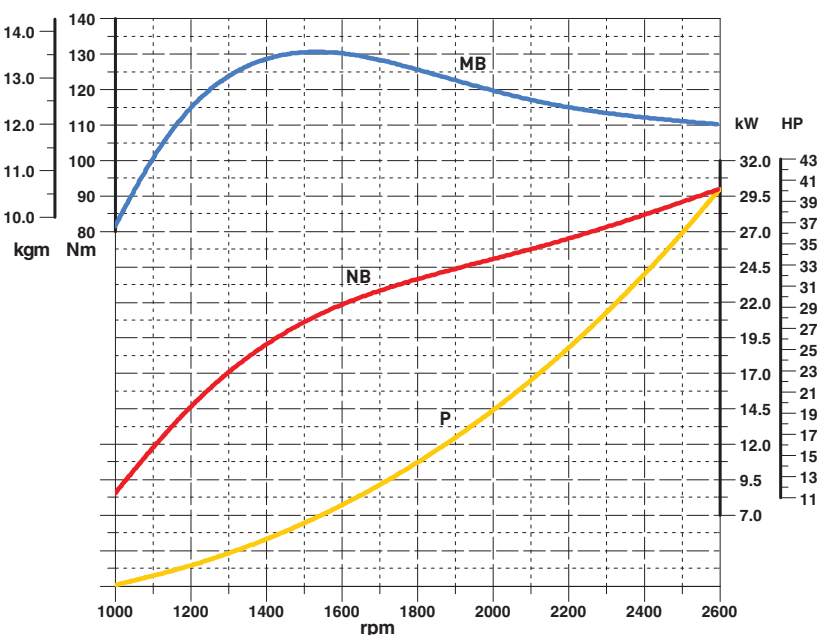

— MB — Torque curve (NB curve) — P — Propeller demand curve  
— NB — Power curve - ISO 3046/1-IFN

Power ratings refer to engines equipped with air filter, standard muffler, after running-in period at ambient conditions of +25°C, relative humidity 30% and 1 bar. Power levels drop by 1% every 100 m altitude and by 2% every 5°C above +25°C.

# KDI 2504M-MP

## QUICK SPECIFICS

**4** Mechanical Engine  
CYLINDERS

**50.0** | **36.4** @ 2600 rpm  
HP kW STAGE III A

**170** @ 1500 rpm  
Nm

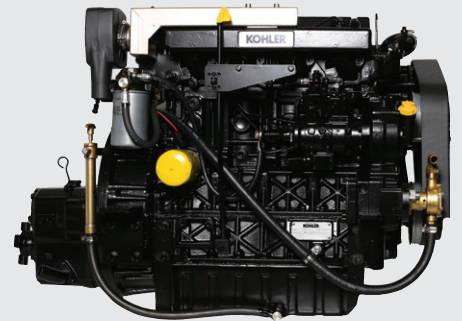

## STANDARD EQUIPMENT

- Digital De Luxe-panel
- Alternator 12V - 120A
- Electric starting
- Oil extraction pump
- 100Nm PTO facility
- V-belt safety cover
- Exhaust mixing elbow
- Fresh water expansion tank
- Sea water pump front mounted

## ACCESSORIES ON DEMAND

- Set of flexible engine mounts
- Hot water take-off kit
- Second station harness and panel
- Oil pressure sensor for Digital De Luxe-panel
- NMEA 2000 convertor for Engine monitory system

## DATA

### DIMENSIONS (mm)

KDI 2504M-MP with TMC260 marine gear

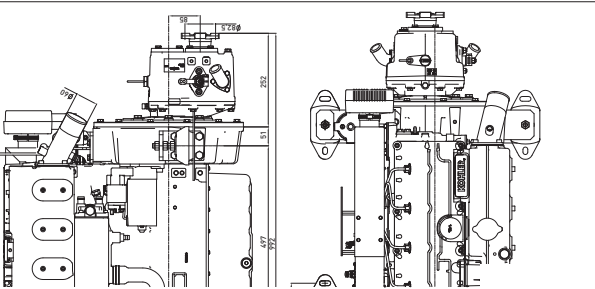

### PERFORMANCE CURVES (ACCORDING TO ISO 14396)

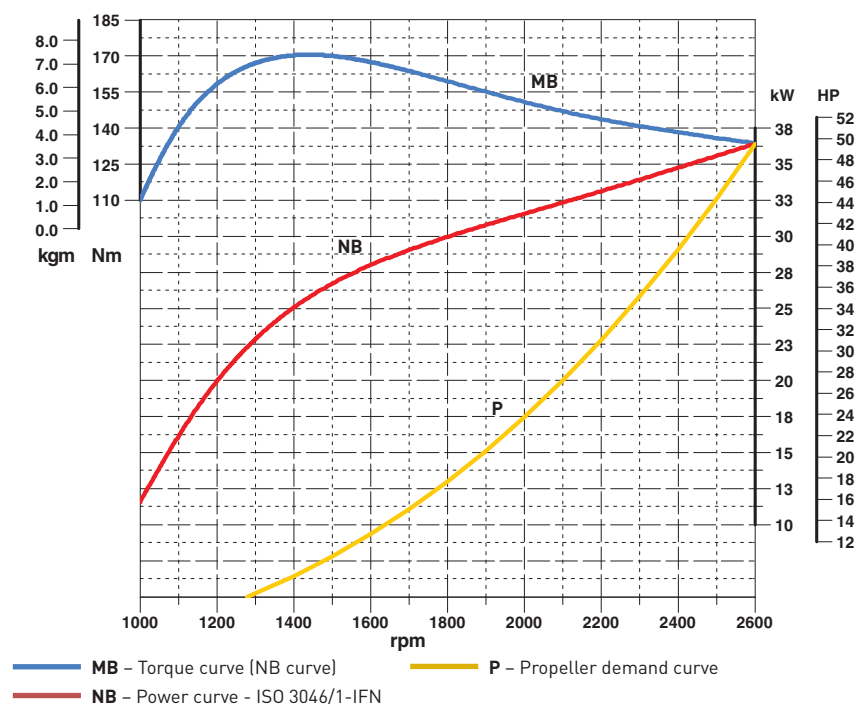

Power ratings refer to engines equipped with air filter, standard muffler, after running-in period at ambient conditions of +25°C, relative humidity 30% and 1 bar. Power levels drop by 1% every 100 m altitude and by 2% every 5°C above +25°C.

# MECHANICAL ENGINES



Model		KDI 1903M-MP	KDI 2504M-MP
<b>Engine specs</b>	4 stroke diesel with cylinder in line	•	•
	Liquid cooling	•	•
	4 valves per cylinder	•	•
	In crankcase camshaft, gear train driven	•	•
	Pushrod - rocker arms timing with hydraulic tappets	•	•
	Cast iron crankcase with bed-plate	•	•
	Cast iron cylinder head	•	•
	Closed crankcase ventilation system	•	•
<b>Technical features</b>	Cylinder	3	4
	Bore (mm)	88	88
	Stroke (mm)	102	102
	Engine displ (cm <sup>3</sup> )	1861	2482
	Injection system	DI	DI
	Injection Equipment	Mech-Rotary pump	Mech-Rotary pump
	Starting system	Electric starting 12V	Electric starting 12V
	Alternator	12V-120A	12V-120A
<b>Performance</b>	Emission compliance	STAGE III A	STAGE III A
	Max power (IFN - ISO 3046 and ISO 14396) (HP@rpm)	40.8@2600	50@2600
	Max torque (IFN - ISO 3046 and ISO 14396) (Nm@rpm)	133@1500	170@1500
<b>Physical characteristics</b>	Dry weight without gear (kg)	240	285
	Daily service points - positions	1 side service	1 side service
<b>Auxiliary PTOs</b>	Max torque (Nm)	100	100



Lombardini Marine is a division of Lombardini s.r.l., part of Kohler Group.

Lombardini has manufacturing facilities in Italy, Slovakia and India and sales subsidiaries in France, Germany, UK, Spain and Singapore.

Kohler/Lombardini reserves the right to make modifications without prior notice.

[www.lombardinimarine.com](http://www.lombardinimarine.com)

## SALES OFFICE

### Lombardini Marine

Via Cav. del lavoro  
A. Lombardini n° 2  
42124 Reggio Emilia, Italia  
T. +39 0522 389311  
F. +39 0522 389298

e-mail: [sales@lombardinimarine.com](mailto:sales@lombardinimarine.com)